

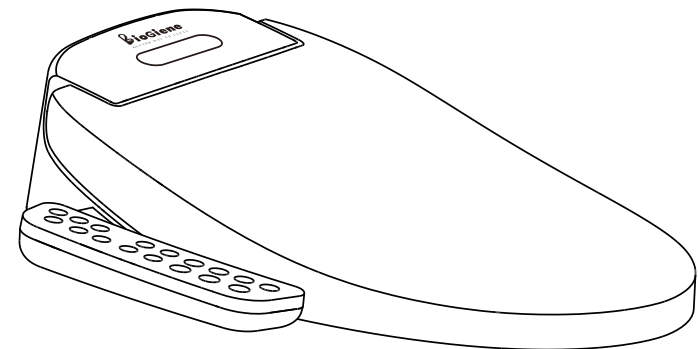

# Smart Toilet Seat Bidet



Model # BG 2910-ARE  
Elongated Bidet Seat

## Product Manual

Thank you for using this product, To make it easier for you to use this product correctly.  
Please read the User's Guide carefully and keep all the information in a safe place.

**Warranty :**

1 year Limited Warranty includes repair and labor. If not repairable , unit will be replaced. Warranty doesn't cover shipping charge.

## Trouble Shooting guide

S/N	Failure name	Fault symptom	Failure measures and steps
1		Plug indicator light is not on	Check on whether the leakage protection plug is insert well
			Whether the leakage switch trips and reset on it
			Power cut or not
2	Water is not come out from the nozzle	No water comes out	Water supply stop or not, wait for the restoration of water supply
			Valve opens or not, open the valve
			Three way valve is block or not, and clean the three way valve after close on the valve
			Check whether the water inlet pipe is folded or not, straighten it out
3	Water flow out rate is slow	Low water pressure	Water pressure is normal or not, wait for the restoration of water supply
			Valve opens or not, open the valve
			Three way valve is block or not, and clean the three way valve after close on the valve
			Check whether the water inlet pipe is folded or not, straighten it out
			Set on the highest setting for the clean water level
4	Water is not heating	Abnormal water supply	Whether the water volume is small or suddenly, the water source in the home is caused by the unstable source of the home The toilet flushing function has just caused the toilet water tank to enter the water, which affects the amount of water.
		Improper settings	Whether the water temperature is set in the normal temperature gear, and the gear is reset.
5	Nozzle is not at the place	Improper settings	Check whether the cleaning position is in the last gear, or return on the power after disconnecting the main power
		Unable to stretch out	Press the seat sensor when you are not seat on, enter the seating state, and then turn on the cleaning function. If the nozzle can extend it, the main reason is that the ceramic deformation is too large. Method IV, 5.4 adjustment.
6	Blowing cold wind when drying	Incorrect setting	Wind temperature gear setting is correct or not, reset on
7	Press buttons not works, remote control not works	Seat on or not	Check on if you are seat on, the machine is not executed any orders without seat on state.
		Remote control receiver is works or not	Remote control receiving disturbance caused the receiving not to be lit, re -code, press the shower key for 5 seconds, and then press the shower key on the remote control after listen on a remind voice.
		Insufficient electricity volume of remote control device	Remote control device is caused by insufficient electricity, change the battery
8	Seat temperature is not heating	Incorrect setting	The settings are improper, whether the gear settings are accurate, and increase the temperature gear to a higher level

## Catalog

- 01 Warning
- 02 Safety Guidelines
- 03 Product Description
- 03 Elongated model dimension
- 04 Product specifications
- 05 Product list
- 05 Installation requirements
- 06 Installation
- 09 Product Display
- 09 Standard model instructions
- 11 Trouble Shooting guide





## Warning

- This product must be used correctly. If it is incorrect, it will cause electric shock when failing and leakage. (Construction and confirmation of ground connection, please entrust professionals to do it)
- Do not power the product through an external switch device. (For example: timer or connect to a regular and disconnected circuit that is connected to the general component)
- Be sure to scrub the detergent after cleaning the machine, avoid it remain on the surface of the machine or on the gap between the toilet and the machine.
  - Do be sure to use the power cord and power plug correctly
  - If it is improper, it will cause fire or electric shock
  - Feem the rated AC 110V power socket.
  - Please confirm whether the power plug is actually inserted to the end before use.
  - When you need to unplug the power plug, you must hold the plug body with your hand and unplug it. Do not pull the power cord directly to pull out the power plug.
  - Do not insert the power plug with a wet hand.
  - Pay the dust on the power plug regularly.
  - Reward the power cord and power plug scratching, processing, close to high temperature, forcibly bending, holding, stretching, and laying heavy objectspower cable
  - At the power plug when you need to repair it, please contact customer service.
- If the soft line of the power supply is damaged in order to avoid danger, it must be replaced by professionals in the manufacturer, its maintenance department or similar department.
- Except for professional maintenance technicians authorized by the company, you must not be transformed, disassembled, and repaired without authorization to avoid causing electric shock, fire, and injury due to abnormal work.
- When the following abnormalities occur in this product, they must be stopped immediately when the failure, and the power plug is removed, the water inlet valve is turned off, and the after-sales service personnel are connected immediately.
  - The body or casual seat has cracks or damage.
  - The abnormal sound or scorching smell.
  - In the power line, the power supply is intermittent.
  - The power plug or power cord is abnormal.
  - The body or operation department is hot and abnormal.
- Do not put the lit cigarettes and other combustion into the toilet.
- Do not use tap water and drinking water sources other than water (groundwater).
  - It will cause water leakage due to impurities in the water or foreign body adhesion.
  - Cystitis and skin inflammation will cause cystitis and skin inflammation because water contains microorganisms such as bacteria.
- When using the following populations, the temperature of the seat circle should be adjusted to low (long-term contact with the stool and the skin will cause low temperature burns).
  - Those who are sensitive or slow for children and elderly people, who cannot take temperature regulators, take hypnotic drugs (such as sleeping pills), drunk and extreme fatigue.

## Notice

- Before using it, confirm whether the leakage protection device is working properly; when the leakage protection device is faulty, the product is used.
- Do not insert it into the opening of this product, so as not to cause electric shock.
- When you do not use this product for a long time, please discharge the water on the water side of the product (please refer to "maintained maintenance"), and then unplug the power plug.
- If the remaining water is discharged the deterioration of water will cause skin inflammation.
- Please abide by the following precautions to avoid injuries.
  - When handling, you must hold the body with both hands. If you hold the seat or cover with one hand, the body will be injured away from the body.
  - When the stool and the stool are opened and closed, please be careful not to pinch your fingers.
  - Do not rely on the cover, it will fall or injury due to the rupture of the stool.
  - Do not sit above the cover or exert impact, it will fall and injury due to the rupture of the stool.
  - Do not support the body's control panel to sit down, stand up or sit directly on the control panel, which will cause falling and injury.
  - When operating the control panel button or closing the toilet cover, do not use brute force, it will cause injuries due to damage.
  - Do not continue to use it when the body's part is falling off, causing injuries to fall or cause injuries due to rupture.
- Do not let children play this product and accessories, so as not to cause injuries and suffocation.
- People with disabilities and people who lacks experience or common sense (including children) need to use this product under special personnel.
- To connect water source appliances from detachable hose components, it is necessary to replace it with a new hose component. The old hose component cannot be reused.

## TurboWash

Press "", the TurboWash function starts to work. Press "" again to adjust the flow of water. The flow has two levels of high and low. After the TurboWash function is turned on, the water flow adjustment keys "" and "" are invalid.

## Dry

When the human body is seated and press "", the warm air can be turned on after drying, and the cycle working time is 180 seconds.

## Flow

During the cleaning process, press the "" "" of this button to adjust the flow of cleaning water.

## Position

In the process of cleaning, press this key "" "" can be adjusted to the cleaning position.

## Water Temp

Press wash water temperature for cycle setting: Normal (no indicator light); Low (approx. 34°C, small indicator light on); Medium (approx. 37°C, medium indicator light on); High (approx. 40°C, big indicator light on).

## Seat Temp

Press seat temperature for cycle setting: Normal (no indicator light); Low (approx. 34°C, small indicator light); Medium (approx. 37°C, medium indicator light); High (approx. 40°C, big indicator light).

## Dry Temp



Press dry temperature for cycle setting: Normal (no indicator light); Low (approx. 40°C, small indicator light); Medium (approx. 50°C, medium indicator light); High (approx. 55°C, big indicator light).

## Light

Turn the night light on or off when you press "".

## ECO

Press "" to turn on or off the ECO function. When the ECO function is turned on, the cover will beep twice, and when it turned off, the cover will beep once. After the ECO function is turned on, the seat temperature will be turned off.

 — Press "" to turn off the power to the whole machine. Press this button repeatedly to power on the whole machine.

## Product Display

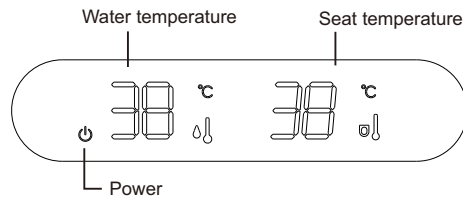

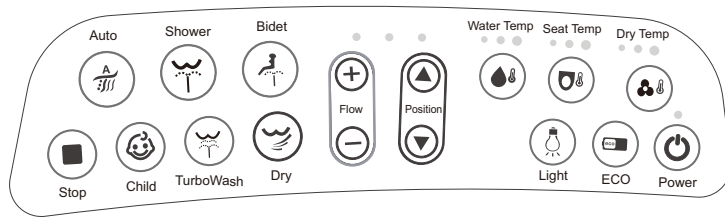

### Standard model instructions





#### — Auto

When the human body is seated and press “”, the spray nozzle automatically extends to clean the hips. Press it again, spray nozzle stops reciprocating cleaning for fixed position cleaning. Working time 90 seconds. After cleaning, it automatically goes into drying.

#### — Shower

When the human body is seated, press “”, the hip wash function starts working. Press “” again, the spray nozzle stops reciprocating cleaning for fixed position cleaning. Working time is 90 seconds.

#### — Bidet

When the human body is seated, press “”, the female cleaning function starts working. Press “” again, the spray nozzle stops reciprocating cleaning for fixed position cleaning. Working time is 90 seconds.

#### — Stop

Press “”, to stop the automatic cleaning, hip cleaning, female cleaning, warm air drying, and so on.

#### — Child

When pressing “”, the children's washing function starts to work, the water volume is at the middle level, the temperature is at the middle level, and neither the water volume nor the temperature can be adjusted.

## Safety Guidelines:

### For Use and Installation

- This product must be connected to a 110v GFCI socket power outlet. Avoid connecting if the power cord or plug if it is broken or looks damaged to avoid electric shock.
- Ensure the power cord plug is completely inserted into the socket.
- Use only GFCI rated power cord extensions, if necessary. The extension should be fixed on a dry wall and ensure there is no exposure to water.
- Only authorized person should repair the product or under consultation with an authorized person.
- It is advised that young children are supervised for use of this product.
- Temperature settings for heat and water pressure should be kept at low for elderly or people having sensitive skin. Use adequate judgement for pressure setting and heat setting for your comfort and usage.
- Ensure that this product is connected to potable water supply.
- Use mild and neutral cleaning agents appropriate to clean plastic surfaces for cleaning the toilet seat and lid. Please disconnect power by pulling the plug from the socket during cleaning.
- Avoid touching the power cord or plug with wet hands.
- Connect the Power Cord only after complete installation of the product to avoid accidental damage to product or to avoid electrical shock.

## Product Description

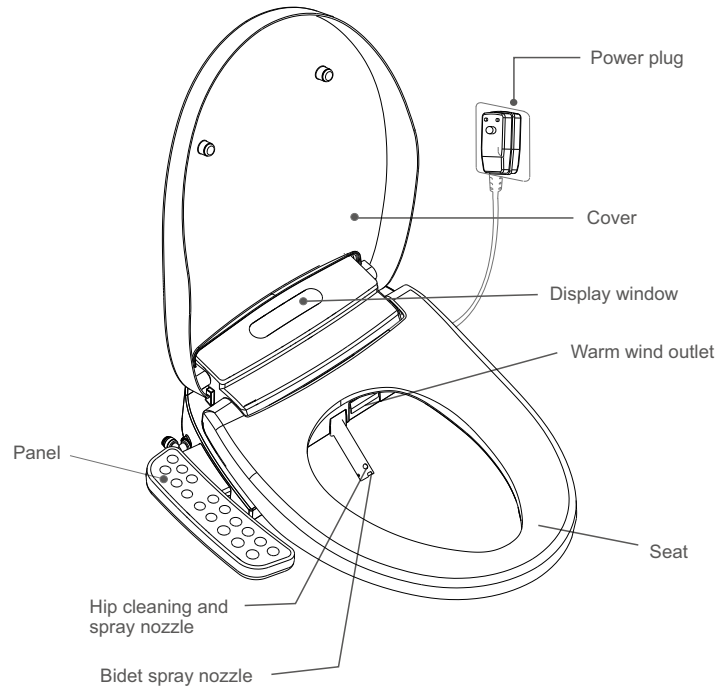

## Elongated model dimension

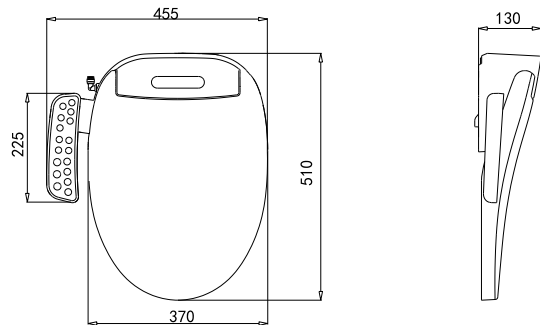

6. Slide Toilet Seat Bidet into the fixing plate.

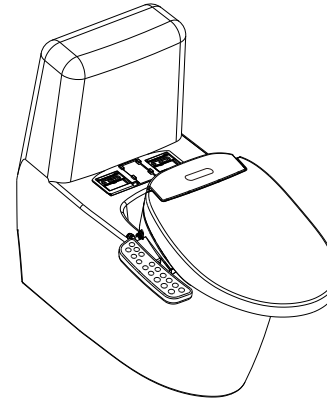

7. Connect Bidet Hose to Bidet.

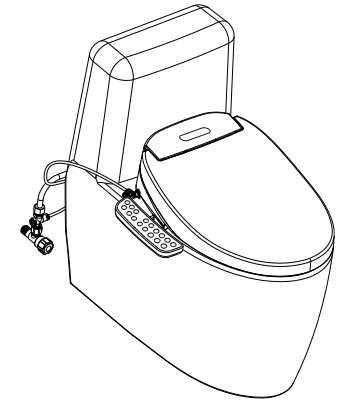

8. Connect Power Plug into wall GFCI socket. LED Indicator will Turn On.

9. Open the water inlet to valve to test for water leakage. If no leakage follow Trial Run instructions.

### Trial run

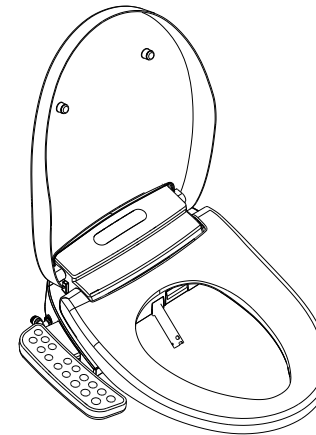

1. Connect the water pipe and open the water valve.

2. Turn on the power, complete the reset, and enter the standby mode.

3. Press the side button or the function button on the remote control in turn to check whether the machine can work normally.

10. If there is leakage, remove cord and tighten the nuts.

5. Attached the connector T Valve to the flush tank and then connect the house to water supply . Use Teflon tape on all connector T Valve threads to avoid water leaks. Hand tighten or use Spanner to slightly tighten

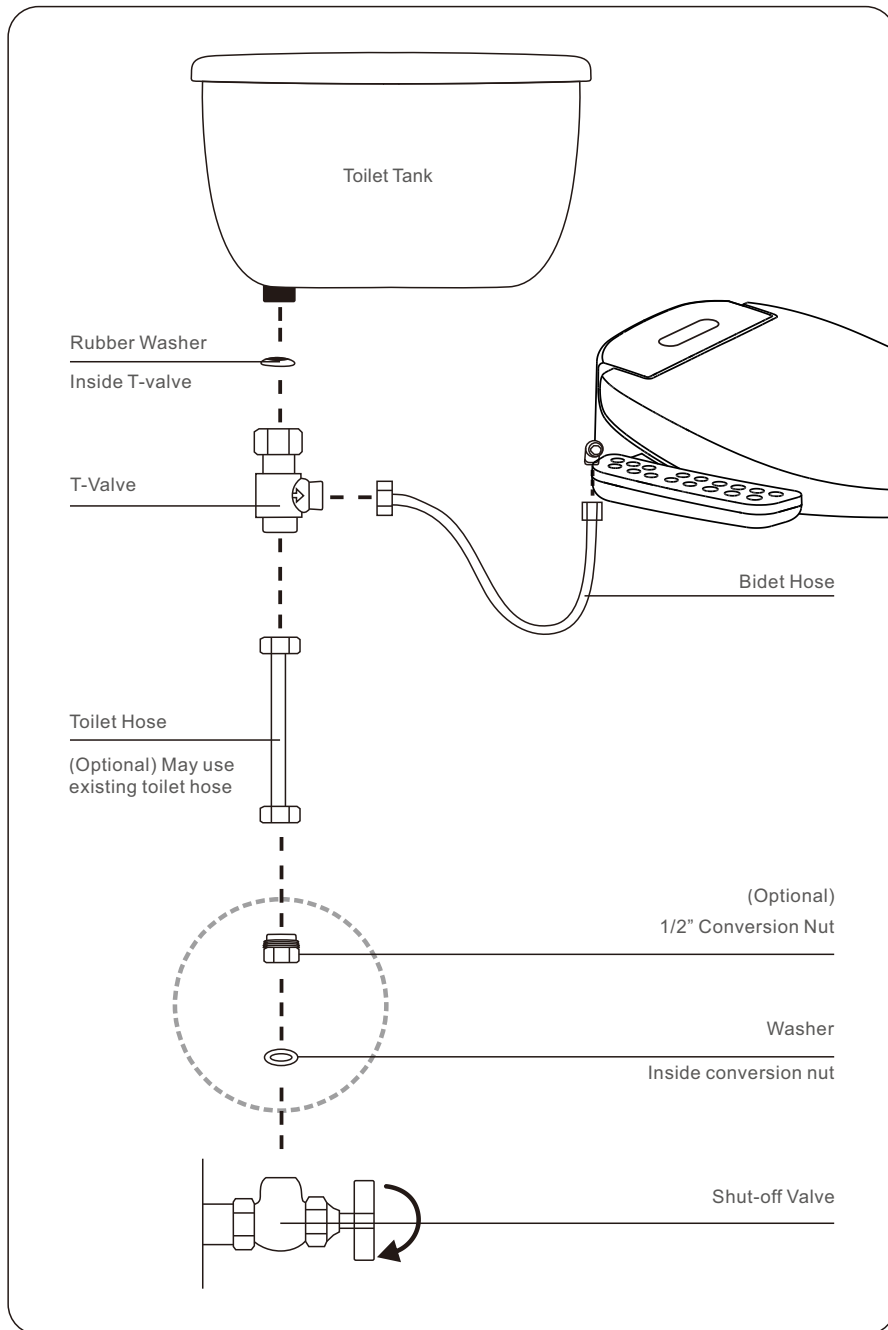

## Product Specifications

Name		Smart Toilet Seat Bidet	
Rated voltage		AC 110V 60Hz	
Rated power		1300W <small>(water inlet temperature 15°C±2°C, ambient temperature 20°C±5°C, the maximum of the seat temperature setting, the maximum flow of hip washing settings, the highest water temperature)</small>	
Power line length		1.2 meter	
Water supply method		Directly connect	
Water pressure		0.08MPa-0.8MPa	
Safety device		Leakage protection, water over voltage protection device	
Washing device	Heating method		Instant heating
	Washing water temperature		4 gears (Room - about 40°C)
	Rinse flow rate	Shower	About 0.5-0.8L/min
		Bidet	About 0.5-0.8L/min
	Rinse method	Shower	Mixed flushing
Bidet		Mixed flushing	
Safety device		Temperature control switch	
Warm air drying	Wind temperature adjustment		Normal temperature, low, medium, high (Room - about 55°C)
	Safety device		Dual metal sheet, temperature fuse
	Wind speed		4-7m/s
Seat device	Temperature of the seat		4 gears (Room - about 40°C)
	Safety device		Temperature fuse
	Switch structure		Seat base and seat cover adopt a damping slowdown device
Note: The temperature of the dry temperature is 5cm away from the air outlet.			
When the water supply and water pressure is lower than 0.08MPa, it is recommended to install a supercharged pump, otherwise it may affect normal use.			

## Product list

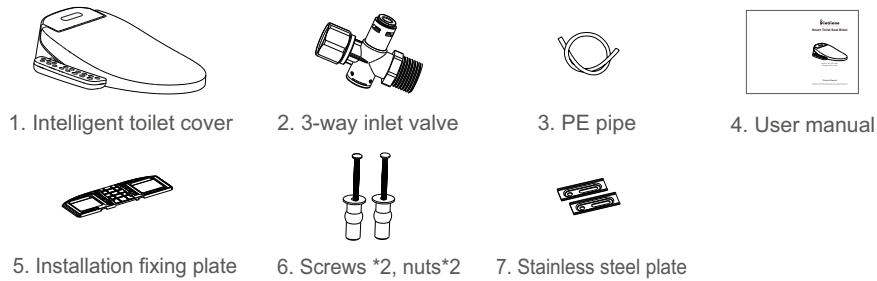

## Installation requirements

### 1. Confirm Ceramic Size Requirements

	Standard	Short
Distance from front end to water tank A	>520	<490
Distance from front end to mounting hole B	445-474	417-446
Distance from the front end to the back wall of the bowl C	>384	>356
Distance from center of mounting hole D	115-185	115-185

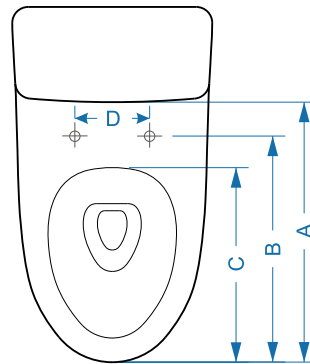

### 2. Check the power and water supply

- This product is for AC110V, 60Hz power supply, and the power socket should meet 110V, specifications.
- When using this product, the tap water pressure must be 0.08MPa-0.8MPa.
- When using water pressure lower than 0.08MPa, it is recommended that users install a booster pump, otherwise it may affect normal use.
- Do not connect the power supply before the installation is completed.
- Be sure to connect the grounding wire. If there is no grounding condition, please commission electrical professionals to install it.

## Installation

1. Turn off water and drain the toilet tank by flushing it twice.
2. Remove the 7/8 Flange connected to the toilet tank.

3. Remove the existing toilet seat from the toilet. You will need a Phillips Screw or Flat Screw Driver.

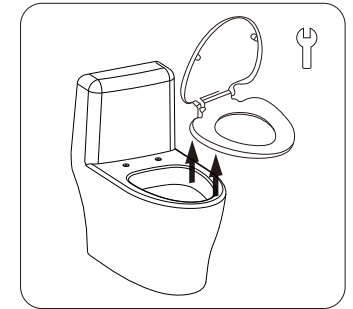
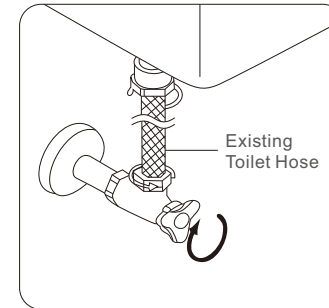

4. Clean the ceramic bowl. Insert the 2 rubber expansion tubes into the 2 holes and then attach the fixing plate with screws supplied.

